

KAZIK 5/36/B2

REF. NR OAW 0101020100S04

DESCRIPTION OF CODE SKU:

- 5 DOORS x 36 PARTITIONS
WITH BINS MODEL B2

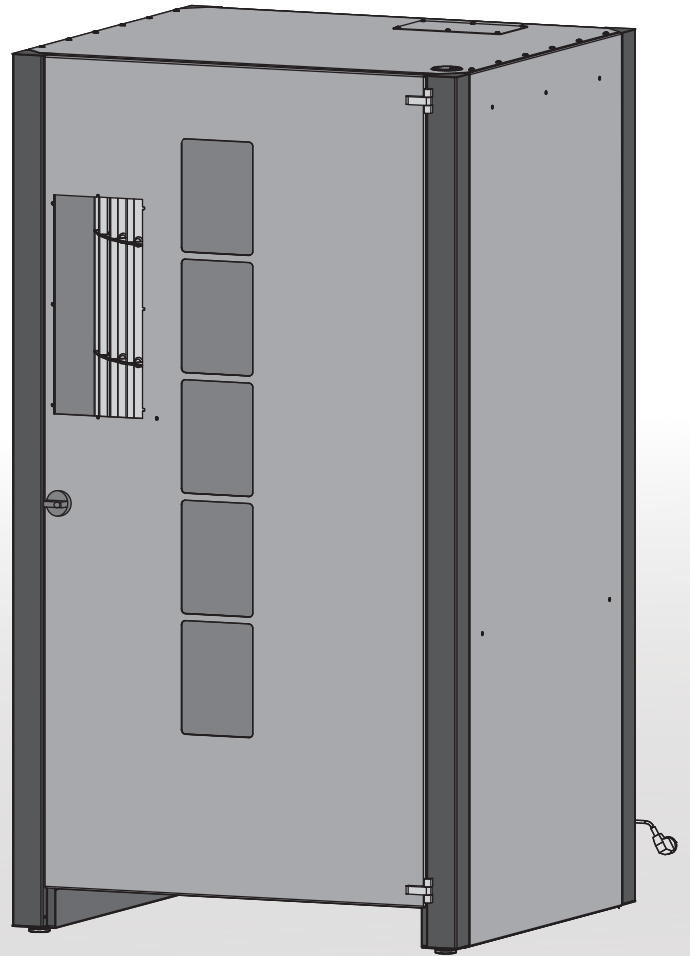

WEIGHT APPROX. 360kg

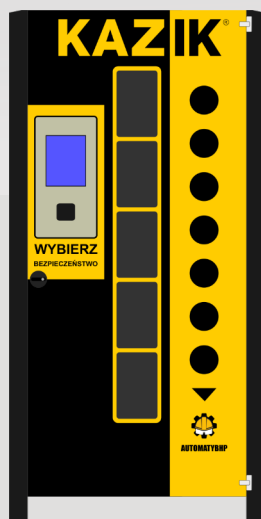

**STANDARD
PAINTING**



*IT IS POSSIBLE TO PERSONALIZE
THE PAINTING FOR ADDITIONAL FEE

**Vending machine
goes through the
door frame:**

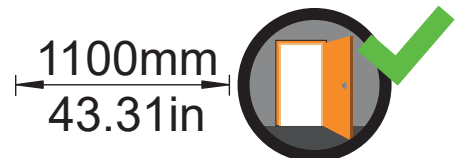

FRONT VIEW

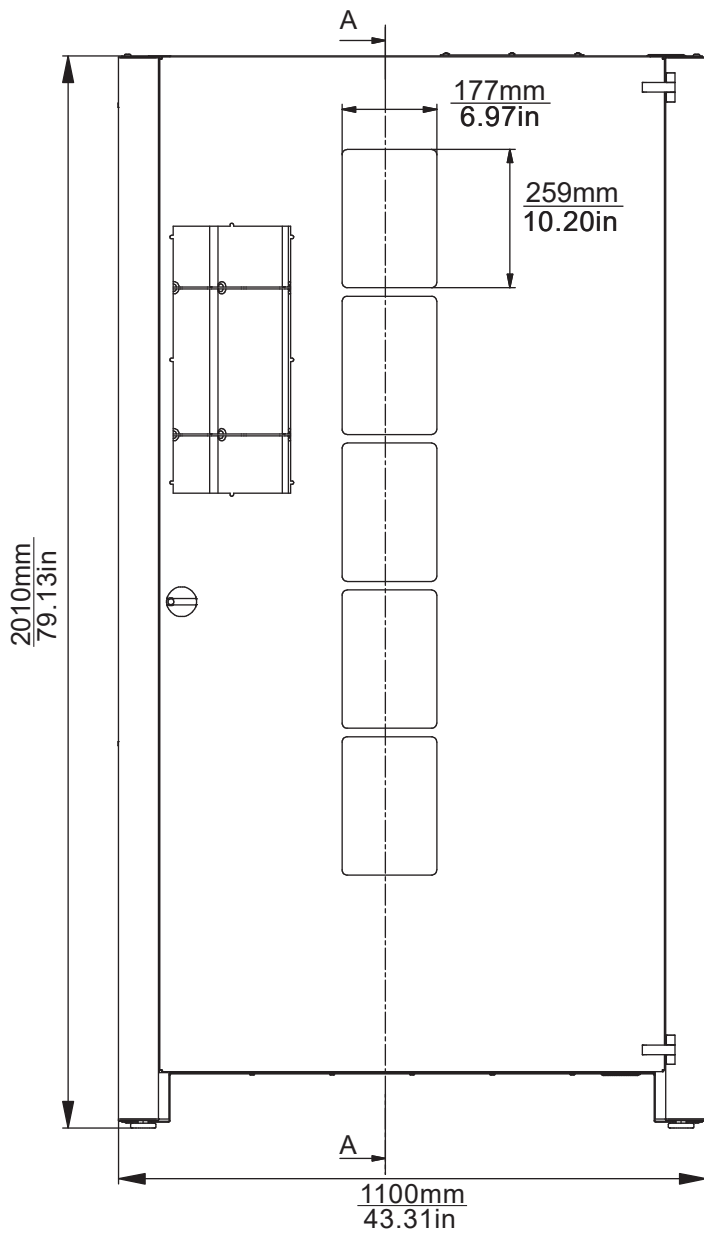

SIDE VIEW

A-A (1:10)

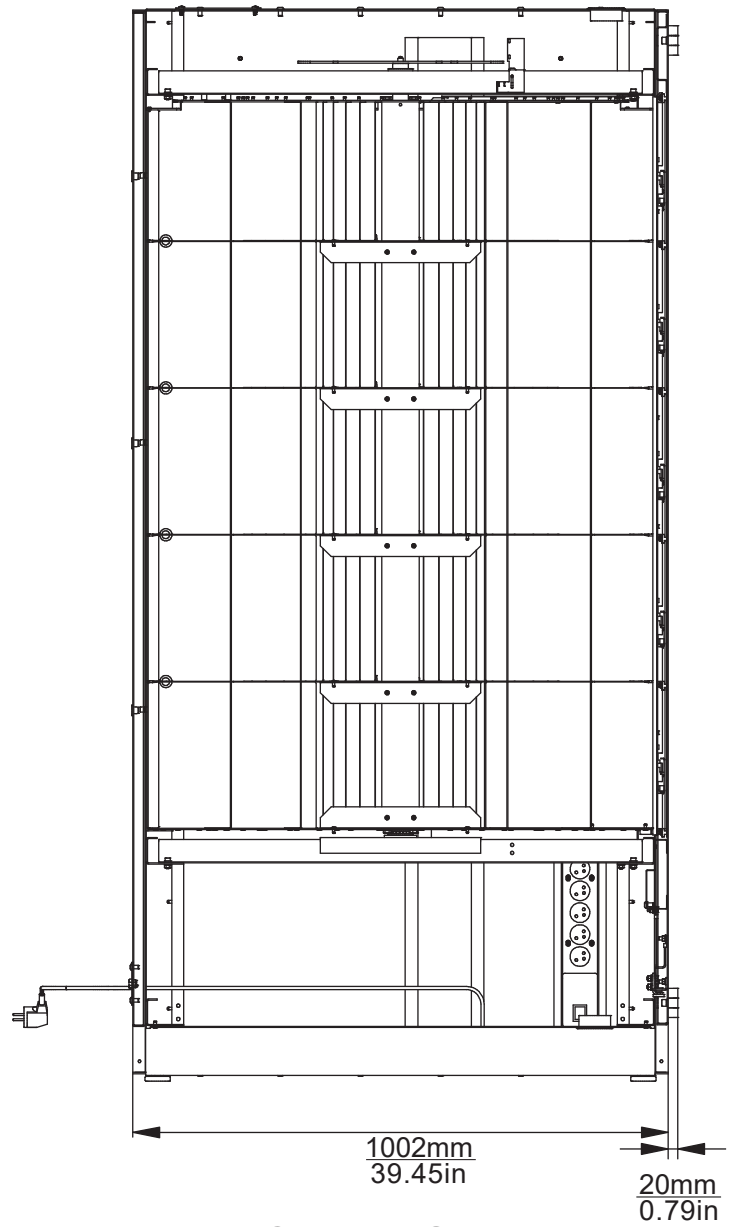

VIEW FROM ABOVE (DRUM)

M-M (1:10)

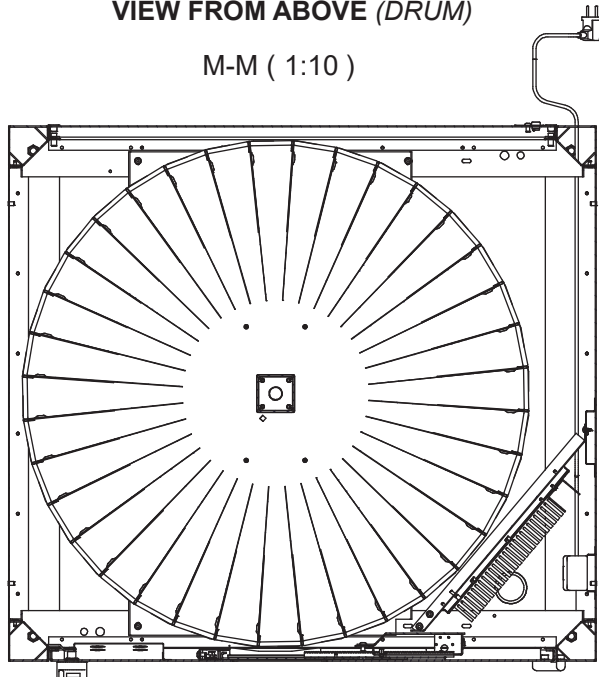

TYPE OF BINS:

TYPE B2

