

# KAZIK 13/36/B6-1/36/B4

REF. NR OAW 0101050100S31

## DESCRIPTION OF CODE SKU:

- 13 DOORS x 36 PARTITIONS WITH BINS MODELU B6
- 1 DOOR x 36 PARTITIONS WITH BINS MODEL B4

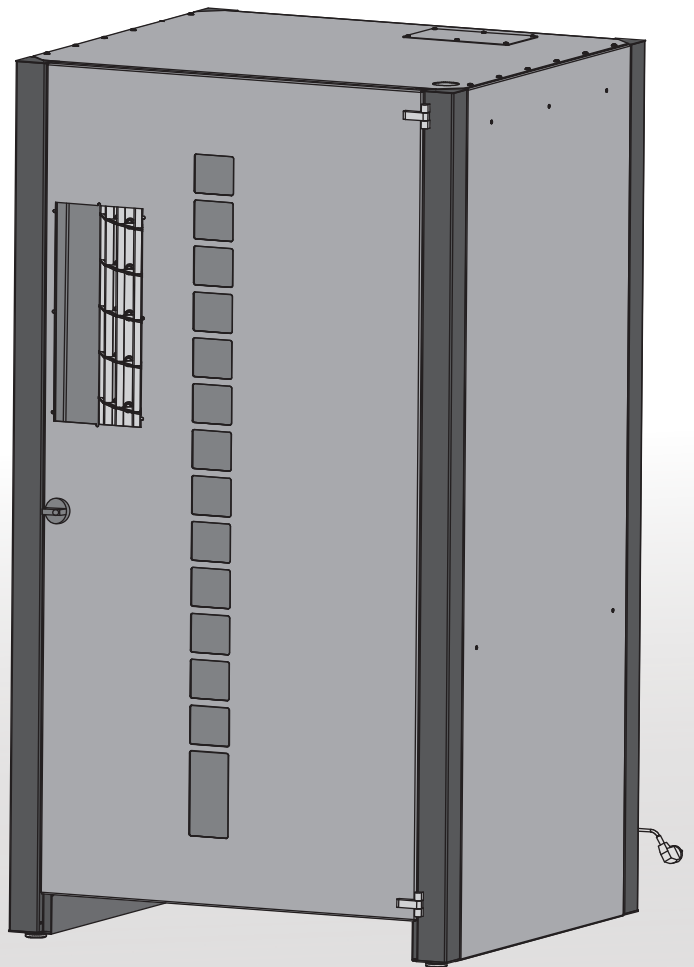

WEIGHT APPROX. 432kg

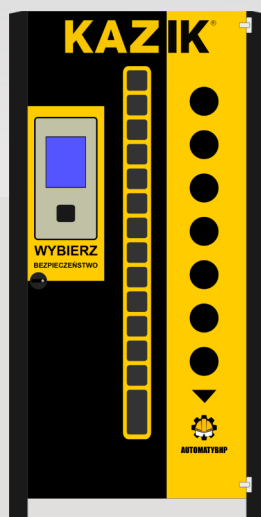

**STANDARD  
PAINTING**



\*IT IS POSSIBLE TO PERSONALIZE  
THE PAINTING FOR ADDITIONAL FEE

**Vending machine  
goes through the  
door frame:**

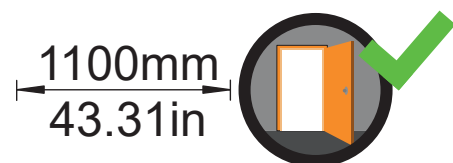

**FRONT VIEW**

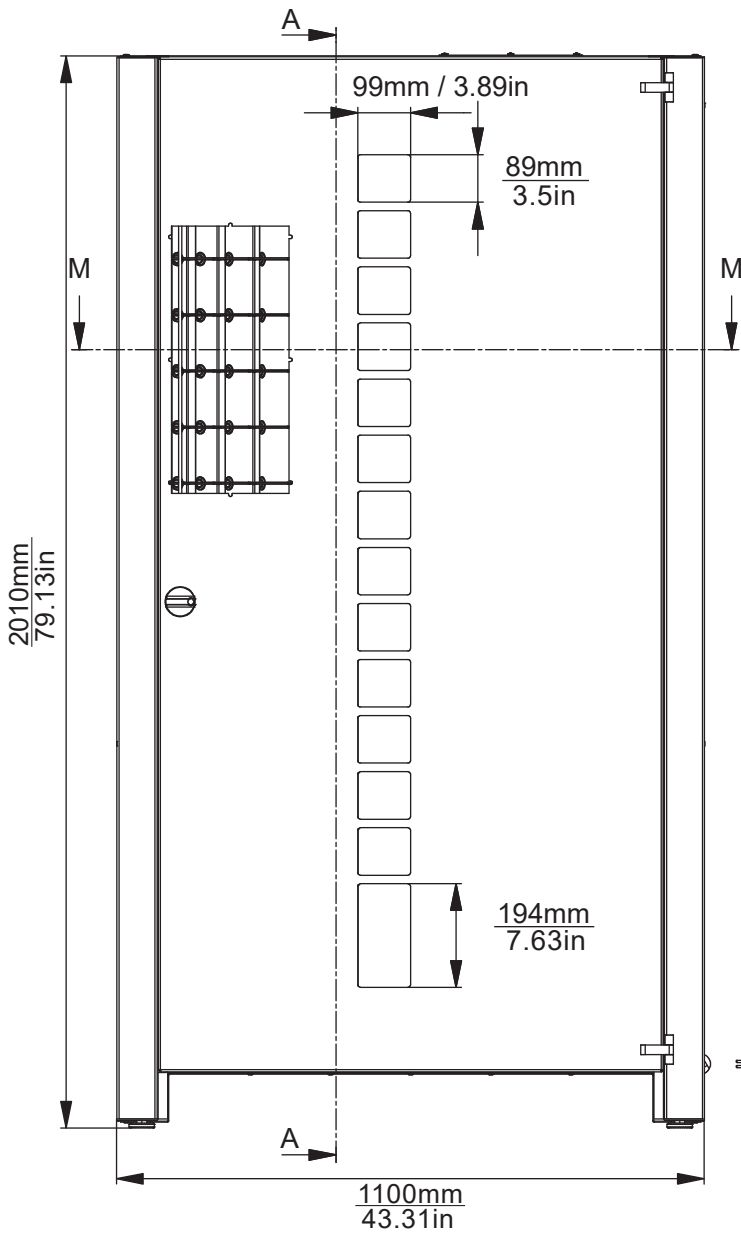

**SIDE VIEW**

A-A ( 1:10 )

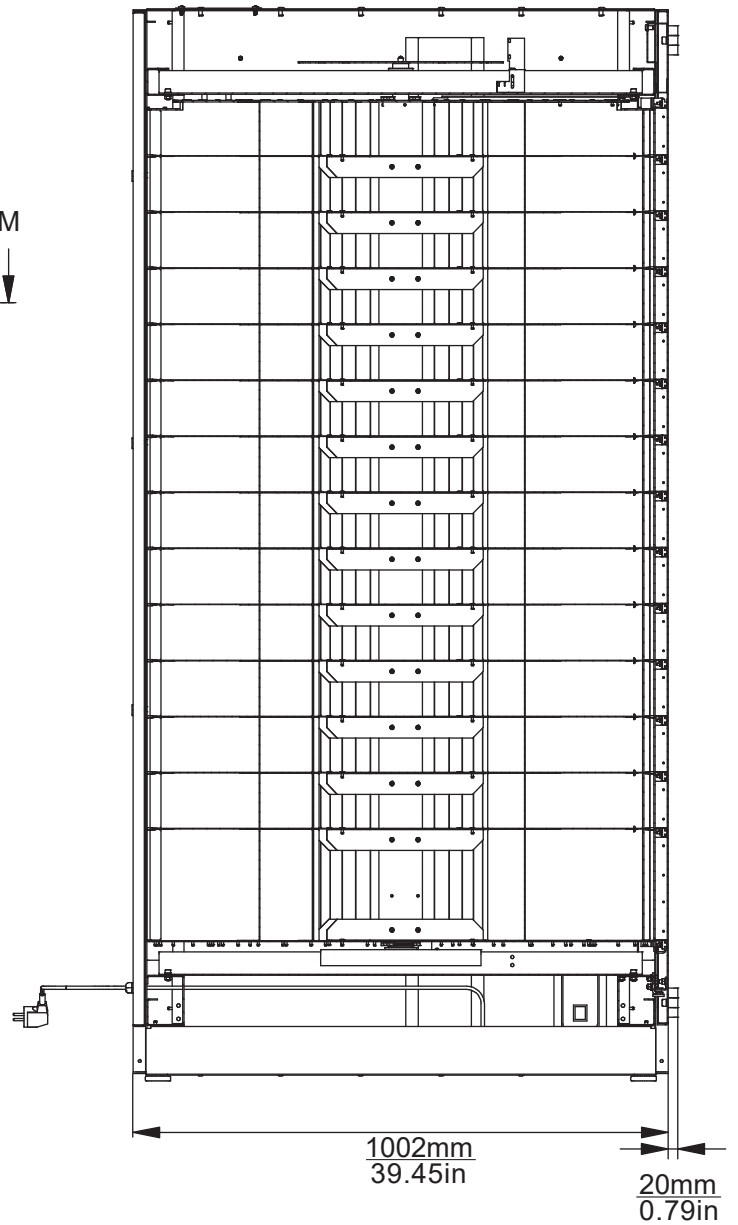

**VIEW FROM ABOVE (DRUM)**

M-M ( 1:10 )

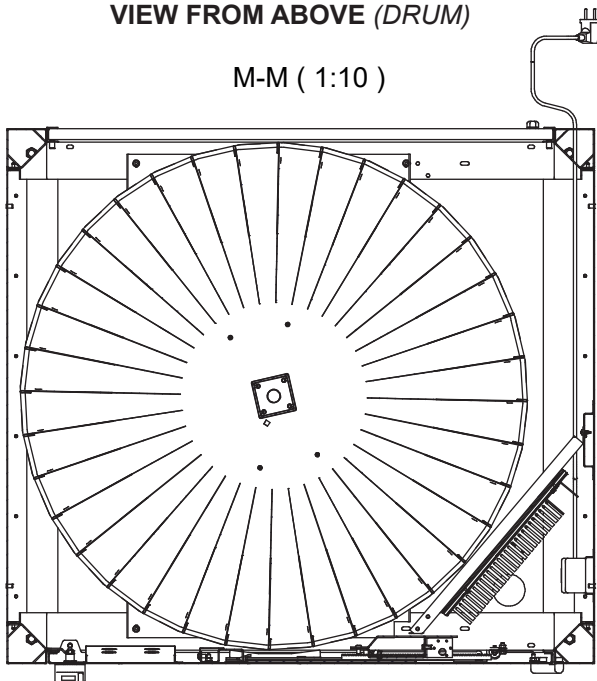

**TYPE OF BINS:**

**TYPE B6**

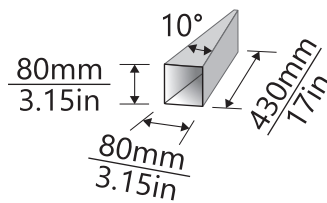

**TYPE B4**

